

AB-Series Molded Case Circuit Breakers UL489 Listed

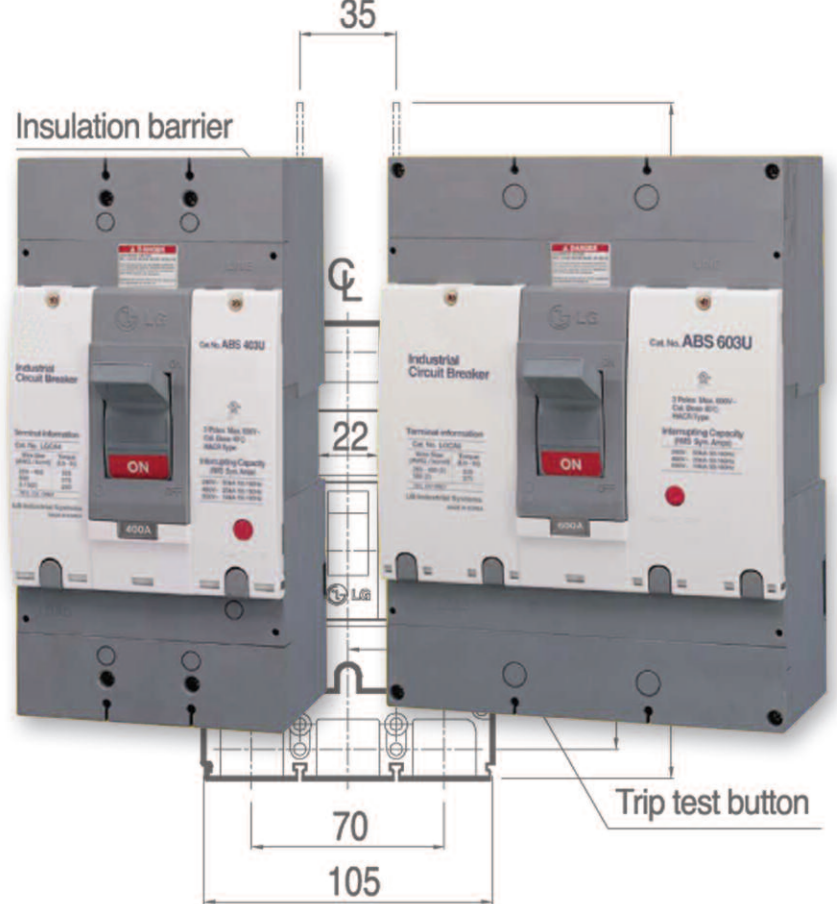

Molded Case Circuit Breaker

- Compact Design
- Thermal Magnetic
- 240, 480, 600VAC
- Up to 100kA Short Circuit interrupting capacity
- Circuit breakers are supplied with line and load terminal
- HACR rated



Current Rating	15-600A
Wire Rating	up to 125A 60°-75°C wire, above 125A 75°C wire only
Calibration Temperature	40°C (104°F)

INTERRUPTING CAPACITY

Model	(RMS Symmetrical Amperes)					
	ABS103U ABS203U	ABH103U ABH203U	ABL103U ABL203U	ABS403U ABS603U	ABH403U ABH603U	ABL403U ABL603U
240VAC	50kA	65kA	100kA	50kA	65kA	100kA
480VAC	25kA	35kA	50kA	25kA	35kA	50kA
600VAC	-	-	-	14kA	18kA	22kA

TERMINAL SIZE ACCEPTABILITY & TERMINAL TORQUE

ABS/ABH/ABL	AWG; kcmil	No. of Connectors	Torque (lb.-in.)
-103U	14-8	1	60
	6-1/0	1	90
-203U	1	1	150
	1/0-2/0	1	180
	3/0-4/0	1	250
	250-300	1	325
-403U	250-400	1	325
	500	1	375
	3/0	2	250
-603U	250-400	2	375
	500	2	375

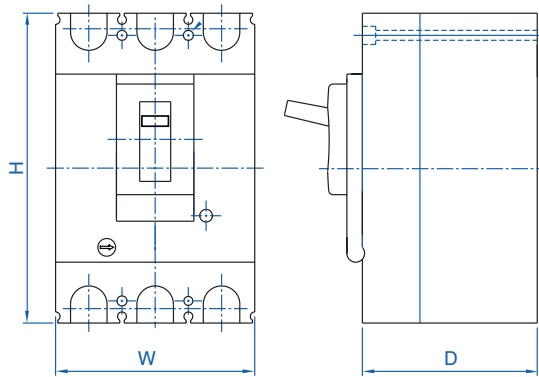

Dimensions

ABS/ABH/ABL	Height (mm)	Width (mm)	Depth (mm)
-103U	185 (7.28 in.)	105 (4.13 in.)	86 (3.39 in.)
-203U	185 (7.28 in.)	105 (4.13 in.)	86 (3.39 in.)
-403U	280 (11.02 in.)	140 (5.51 in.)	110 (4.33 in.)
-603U	280 (11.02 in.)	210 (8.27 in.)	110 (4.33 in.)

MAGNETIC TRIP SETTINGS

ABS/ABH/ABL	Ampere Rating (In)	Magnetic trip Settings
-103U	15A	500A
	20A	500A
	30A	500A
	40A	500A
	50A	500A
	60A	600A
	80A	800A
	100A	1000A
-203U	125A	5,6,7,8,9,10 x In (Adjustable)
	150A	5,6,7,8,9,10 x In (Adjustable)
	175A	5,6,7,8,9,10 x In (Adjustable)
	200A	5,6,7,8,9,10 x In (Adjustable)
	225A	5,6,7,8,9,10 x In (Adjustable)
-403U	250A	2500A
	300A	3000A
	350A	3500A
	400A	4000A
-603U	500A	5000A
	600A	6000A

* UL magnetic trip tolerances are -20% and +30% from the nominal values shown.

AB Series Circuit Breakers

Application Examples:
Power distribution, power generation, motors, etc. Relatively short thermal trip delay and medium magnetic trip point.



LISTED
E231289



ABS
50kA@240VAC
25kA@480VAC
*14kA@600VAC

Rated Current	Type/ Cat. No.
15A	ABS103U15A
20A	ABS103U20A
30A	ABS103U30A
40A	ABS103U40A
50A	ABS103U50A
60A	ABS103U60A
80A	ABS103U80A
100A	ABS103U100A
125A	ABS203U125A
150A	ABS203U150A
175A	ABS203U175A
200A	ABS203U200A
225A	ABS203U225A
250A	ABS403U250A*
300A	ABS403U300A*
350A	ABS403U350A*
400A	ABS403U400A*
500A	ABS603U500A*
600A	ABS603U600A*

Standard Pack: 1

Weight:
15-100A 1.9kg (4.2lb.)
125-225A 2.0kg (4.4lb.)
250-400A 5.6kg (12.3lb.)
500-600A 8.8kg (19.4lb.)



ABH
65kA@240VAC
35kA@480VAC
*18kA@600VAC

Rated Current	Type/ Cat. No.
15A	ABH103U15A
20A	ABH103U20A
30A	ABH103U30A
40A	ABH103U40A
50A	ABH103U50A
60A	ABH103U60A
80A	ABH103U80A
100A	ABH103U100A
125A	ABH203U125A
150A	ABH203U150A
175A	ABH203U175A
200A	ABH203U200A
225A	ABH203U225A
250A	ABH403U250A*
300A	ABH403U300A*
350A	ABH403U350A*
400A	ABH403U400A*
500A	ABH603U500A*
600A	ABH603U600A*

Standard Pack: 1

Weight:
15-100A 1.9kg (4.2lb.)
125-225A 2.0kg (4.4lb.)
250-400A 5.6kg (12.3lb.)
500-600A 8.8kg (19.4lb.)



ABL
100kA@240VAC
50kA@480VAC
*22kA@600VAC

Rated Current	Type/ Cat. No.
15A	ABL103U15A
20A	ABL103U20A
30A	ABL103U30A
40A	ABL103U40A
50A	ABL103U50A
60A	ABL103U60A
80A	ABL103U80A
100A	ABL103U100A
125A	ABL203U125A
150A	ABL203U150A
175A	ABL203U175A
200A	ABL203U200A
225A	ABL203U225A
250A	ABL403U250A*
300A	ABL403U300A*
350A	ABL403U350A*
400A	ABL403U400A*
500A	ABL603U500A*
600A	ABL603U600A*

Standard Pack: 1

Weight:
15-100A 1.9kg (4.2lb.)
125-225A 2.0kg (4.4lb.)
250-400A 5.6kg (12.3lb.)
500-600A 8.8kg (19.4lb.)

Accessories (see page 54-57)

Description	Type
Auxiliary Switch	AX
Alarm Switch	AL
Shunt Trip	SHT
Undervoltage Trip	UVT
Mech. Interlock	MI
Insulation Barrier	IB

*Applies only to AB_403_ and AB_603_ series.

AB-Series Trip Curves

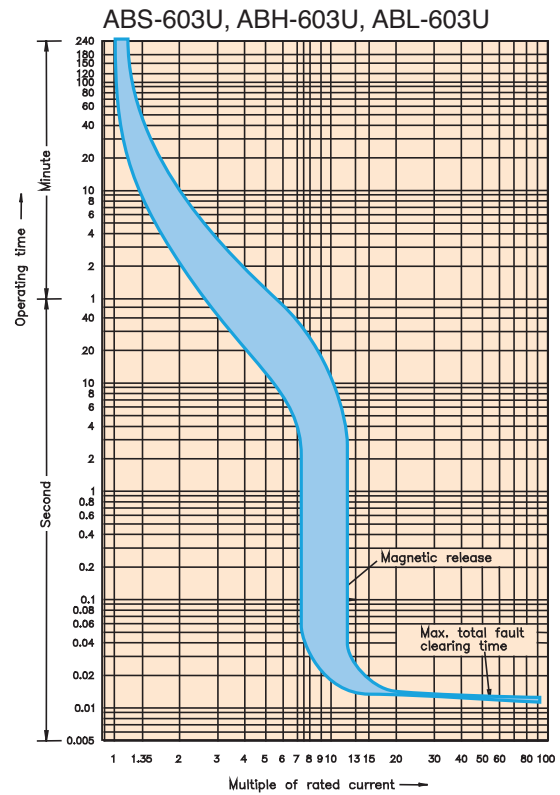
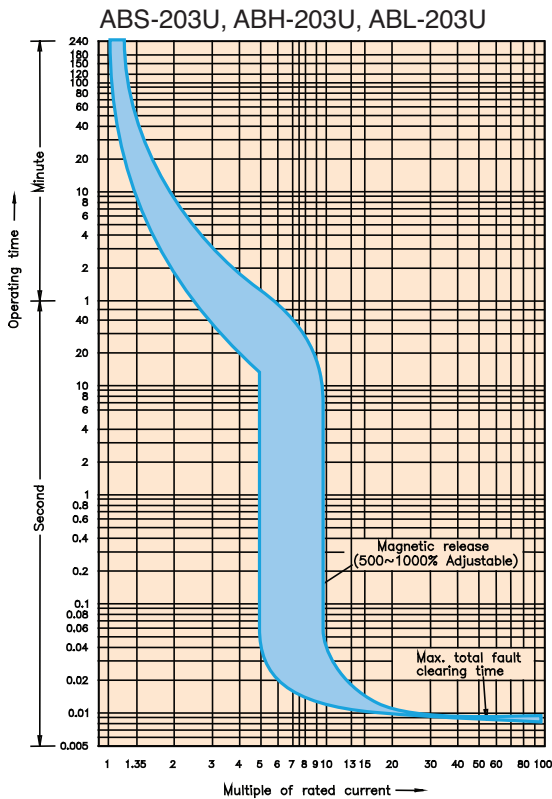
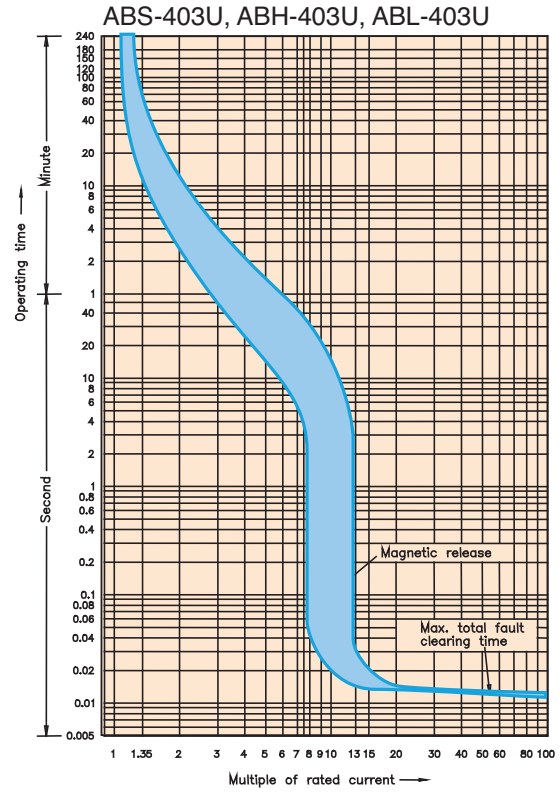
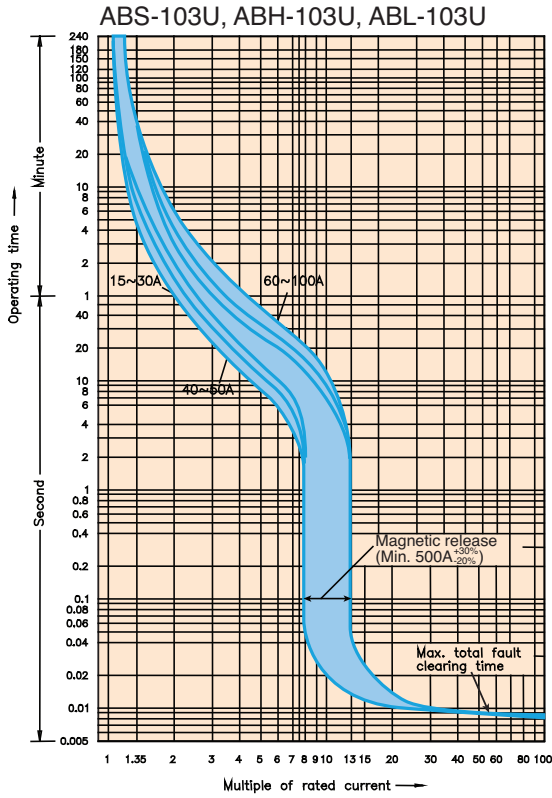

AB Series Circuit Breakers Dimensions

ABS/ABH/ABL 103U

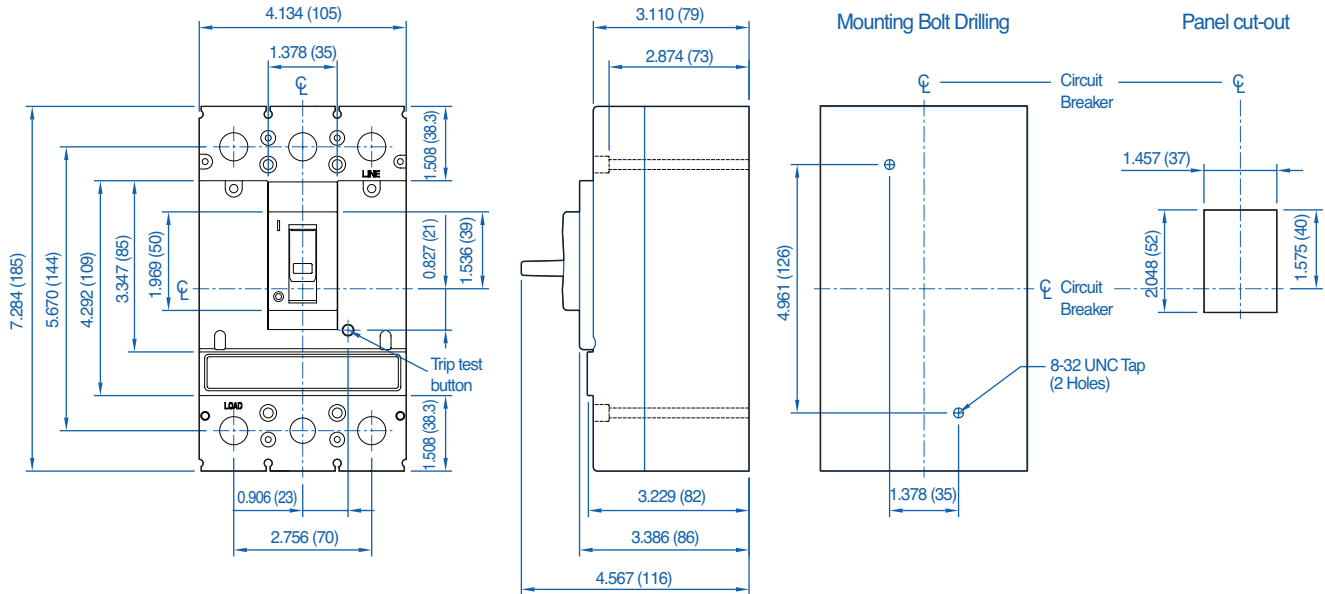

ABS/ABH/ABL 203U

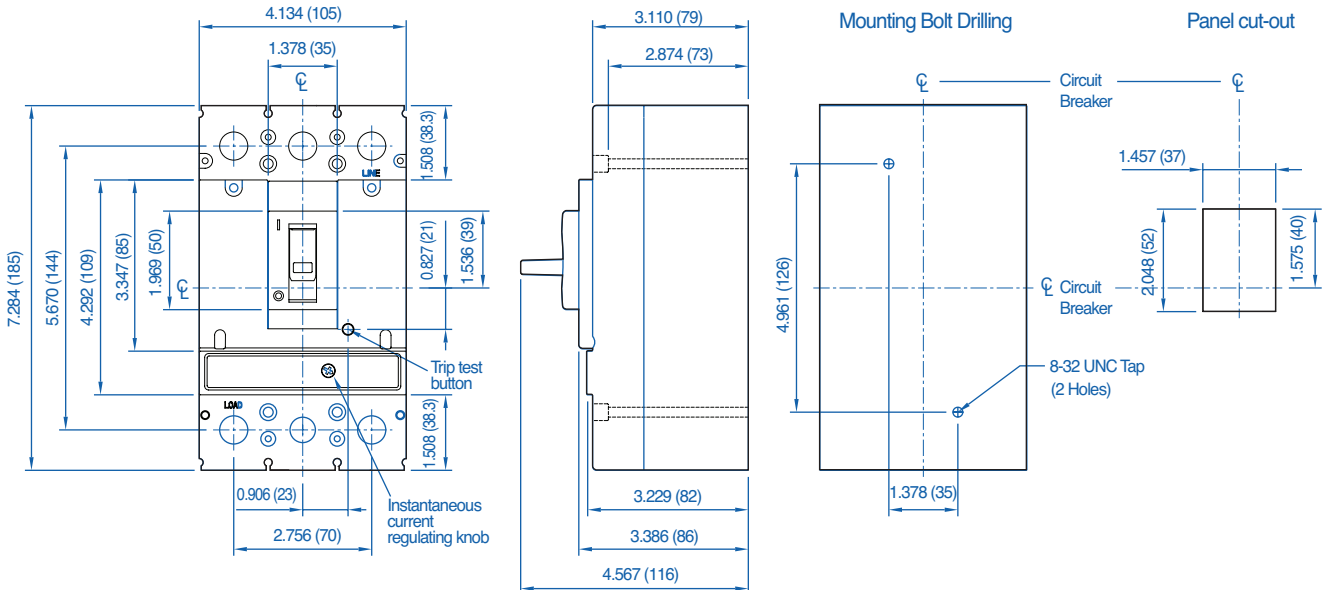

Dimensions shown in inches (mm)

ABS/ABH/ABL 403U

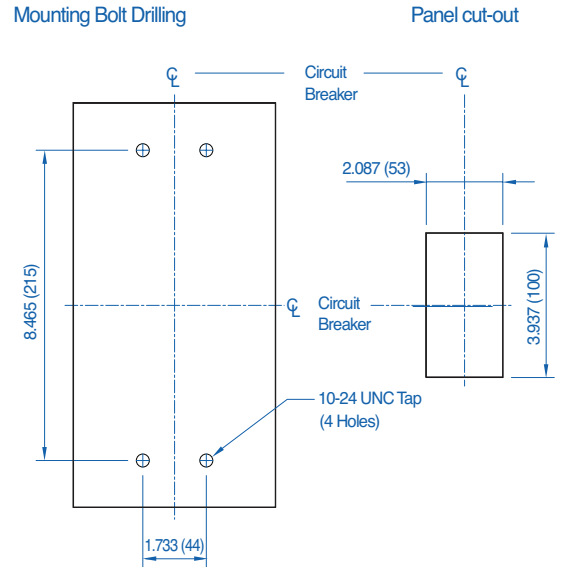
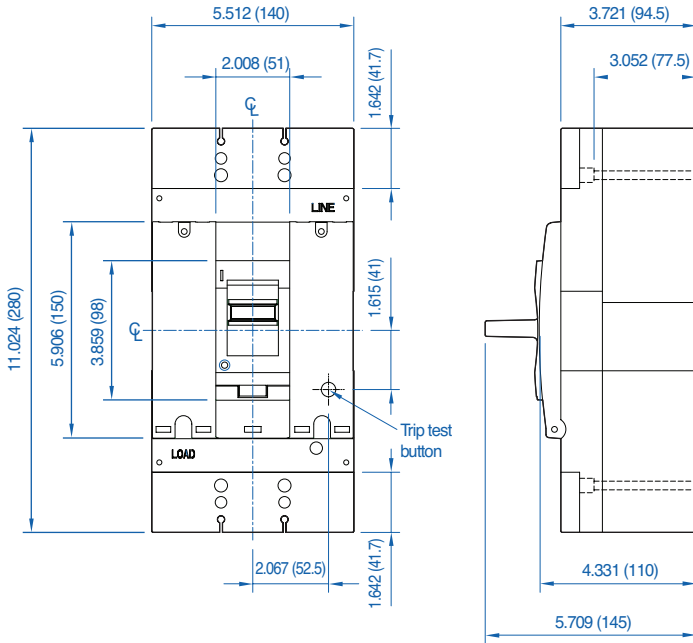

ABS/ABH/ABL 603U

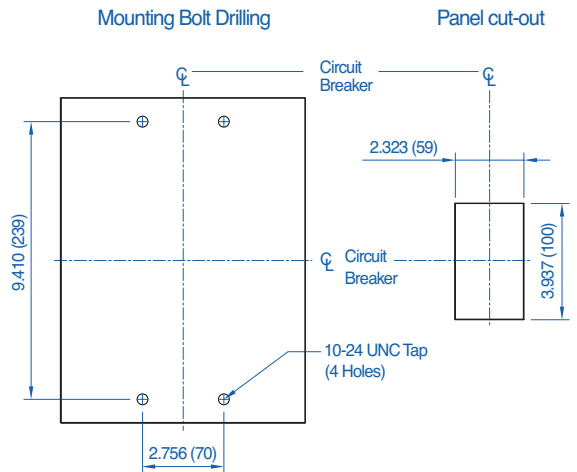
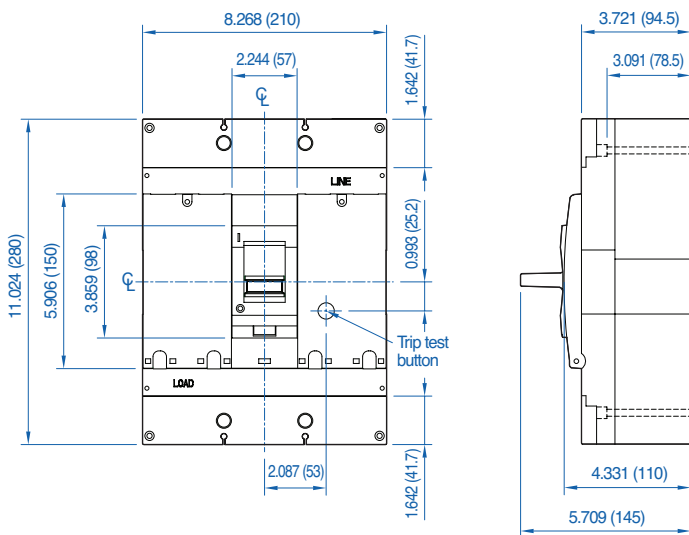

Dimensions shown in inches (mm)

AB Series Door Handle Interlock Mechanism

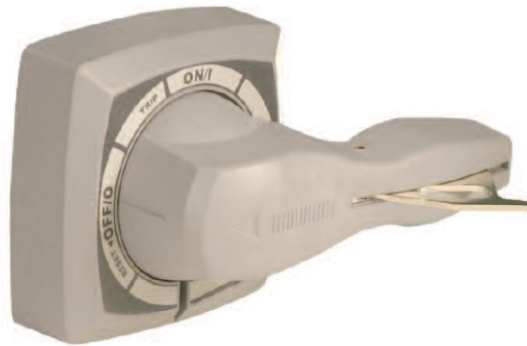

Description	Type/ Cat. No.
Operator Handle Mechanism, grey, for ABS-, ABH-, ABL-103U/203U	HM-100/225AF-G
Operator Handle Mechanism, grey, for ABS-, ABH-, ABL-403U	HM-400AF-G
Operator Handle Mechanism, grey, for ABS-, ABH-, ABL-603U	HM-600AF-G

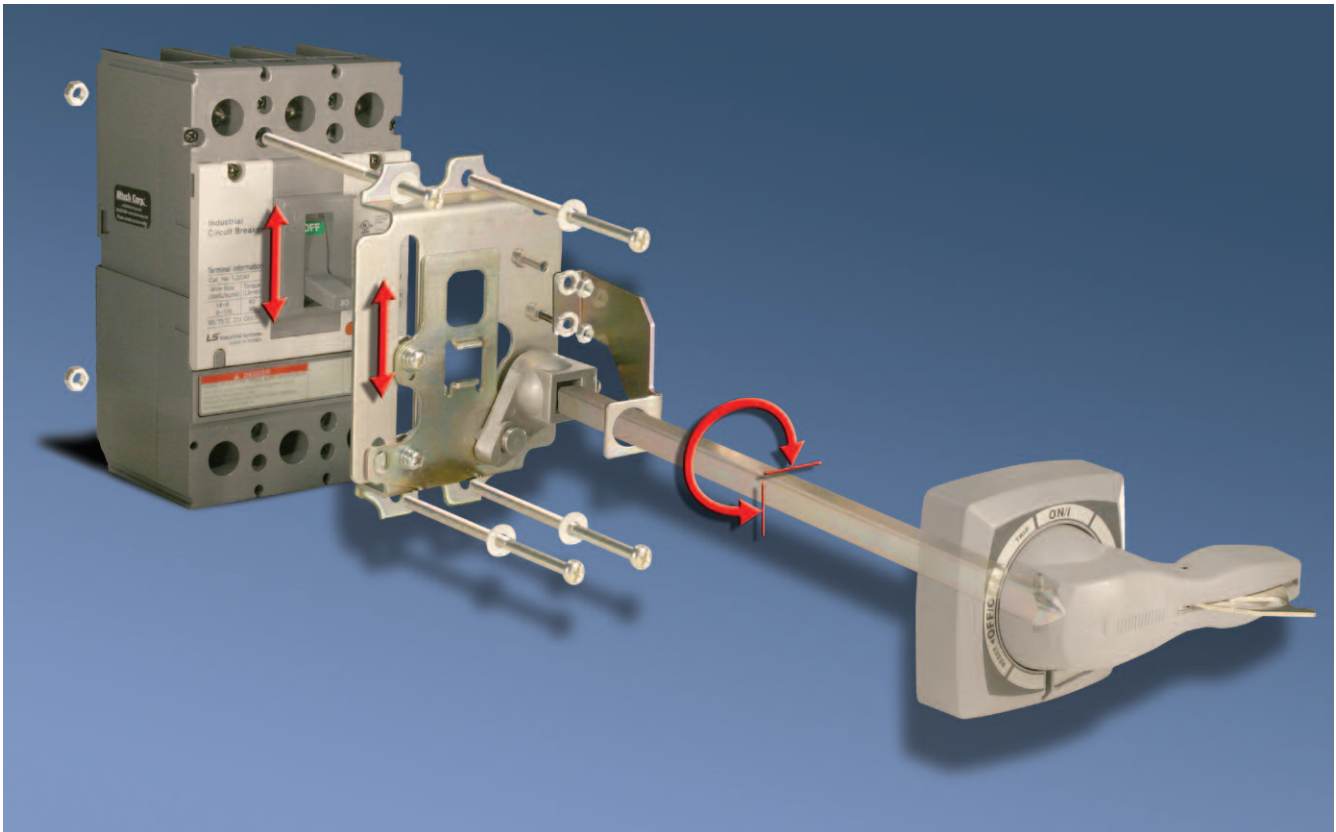

Note: MCCB is not included.

ABS-,ABH-,ABL-103U/203U handle

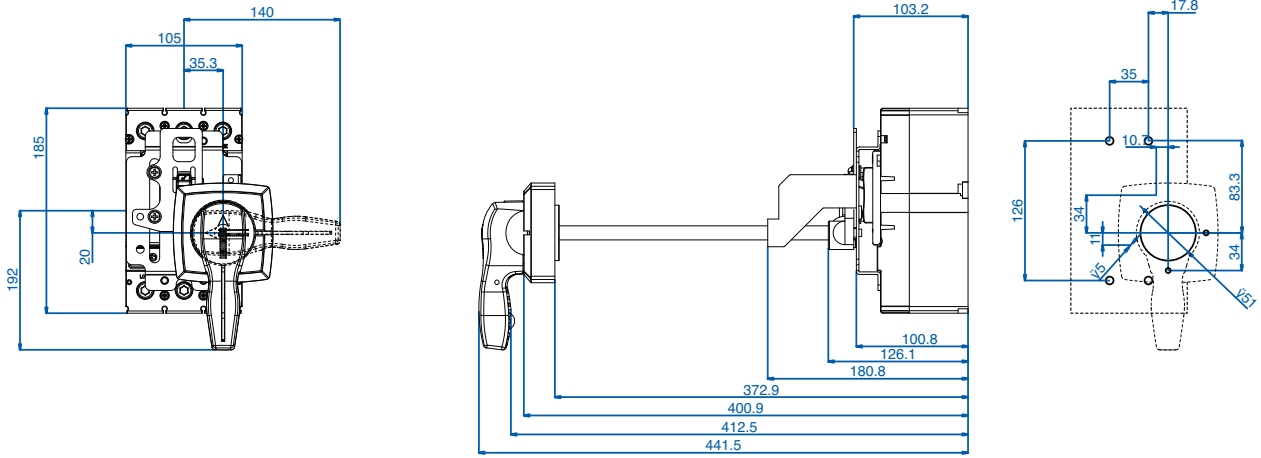

ABS-,ABH-,ABL-403U handle

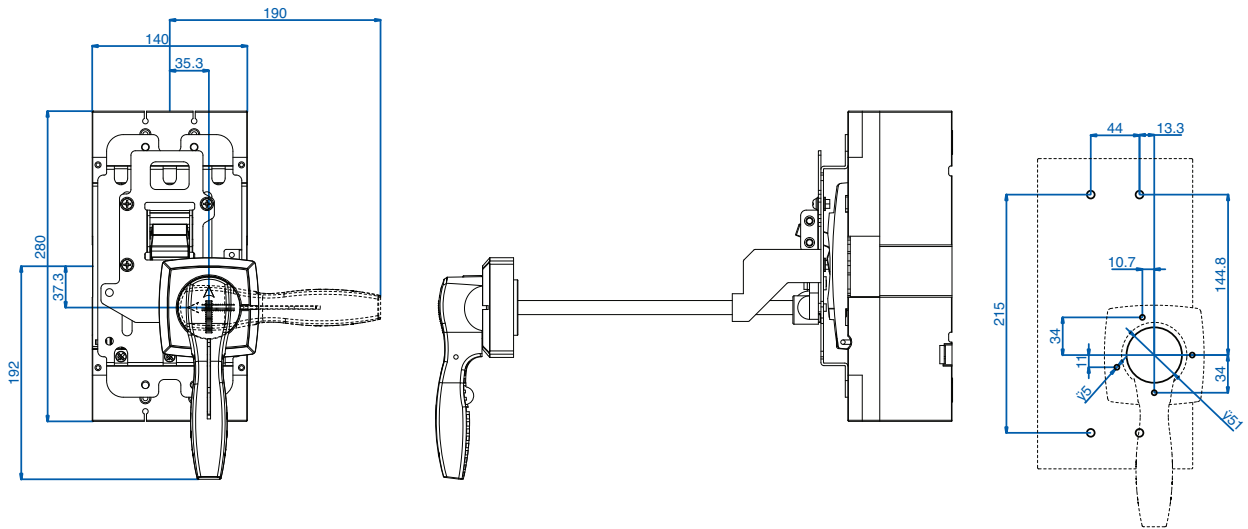

ABS-,ABH-,ABL-603U handle

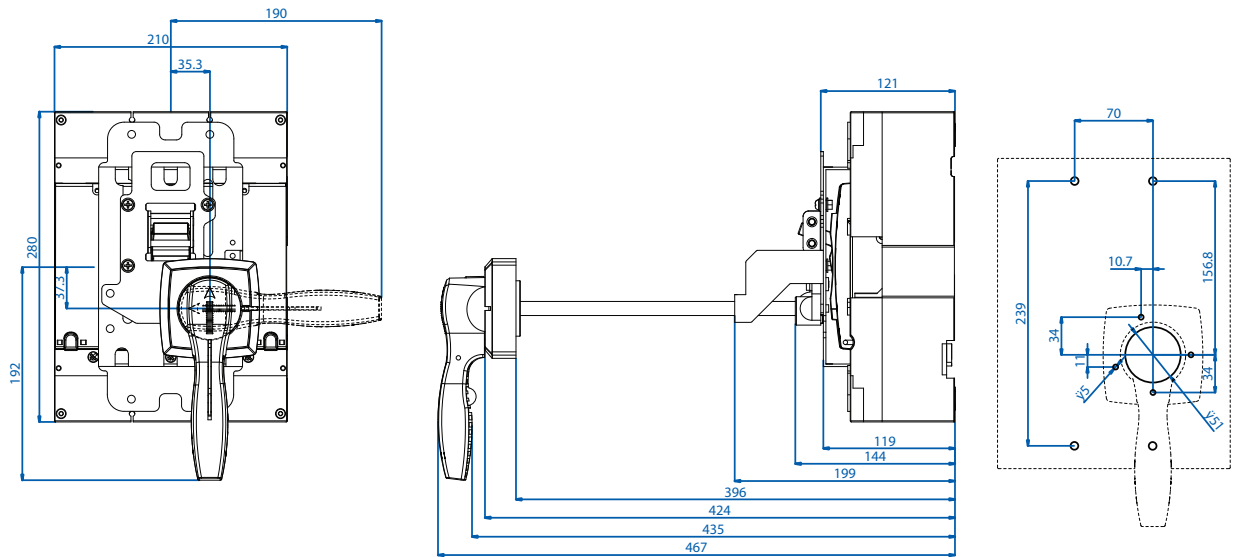

Accessories for

AB Series Circuit Breakers



Auxiliary Switch (AX)

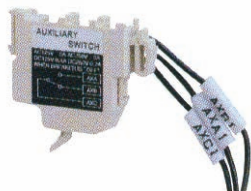

Voltage	Aux. for AB..-103U/203U	Aux. for AB..403U/603U	Switch Type	Switching Current(A)	
				Resistive Load	Inductive Load
125VAC	AXS125AC	AXL125AC	1xCO	5	3
250VAC	AXS250AC	AXL250AC	1xCO	3	2
30VDC	AXS30DC	AXL30DC	1xCO	4	3
125VDC	AXS125DC	AXL125DC	1xCO	0.4	0.4
250VDC	AXS250DC	AXL250DC	1xCO	0.2	0.2

Standard Pack: 1

Weight: 9.0g (0.317oz.)

Alarm Switch (AL)

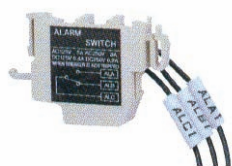

Voltage	Alarm. for AB..-103U/203U	Alarm. for AB..403U/603U	Switch Type	Switching Current(A)	
				Resistive Load	Inductive Load
125VAC	ALS125AC	ALL125AC	1xCO	5	3
250VAC	ALS250AC	ALL250AC	1xCO	3	2
30VDC	ALS30DC	ALL30DC	1xCO	4	3
125VDC	ALS125DC	ALL125DC	1xCO	0.4	0.4
250VDC	ALS250DC	ALL250DC	1xCO	0.2	0.2

Standard Pack: 1

Weight: 9.0g (0.317oz.)

Shunt Trip (SHT) (75-110% of rated voltage)

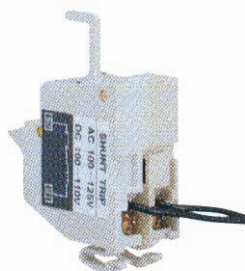

Voltage	Shunt Trip for	
	AB..-103U/203U	AB..403U/603U
AC/DC		
12V	SHTS12VU	-
24V	SHTS24VU	-
48V	SHTS48VU	-
60V	SHTS60VU	-
250V	SHTS250VU	-
24-48V	-	SHTL24VU
100-125VAC/100-120VDC	-	SHTL100VU
200-240VAC/200-220VDC	-	SHTL200VU

AC

100-125V	SHTS100AC	-
200-240V	SHTS200AC	-
380-450V	SHTS380AC	-
440-480V	SHTS440AC	-
500-550V	SHTS500AC	-
380-460V	-	SHTL380AC
480-550V	-	SHTL480AC

DC

100-110V	SHTS100DC	-
125V	SHTS125DC	-
200-220V	SHTS200DC	-
240V	SHTS240DC	-
250V	SHTS250DC	-

Standard Pack: 1

Weight: 9.0g (0.317oz.)

Accessories for AB Series Circuit Breakers



Undervoltage (tripping @ 35-70% of rated voltage)
Trip (UVT) (resetting @ 85-100% of rated voltage)



Voltage	Undervoltage Trip for AB..103U/203U	Undervoltage Trip for AB..4103U/603U
AC/DC		
24V	UVTS24VU	UVTL24VU
48V	UVTS48VU	UVTL48VU
100-110V	UVTS100VU	UVTL100VU
200-220V	UVTS200VU	UVTL200VU
AC		
380-450V	UVTS380AC	UVTL380AC
440-480V	UVTS440AC	UVTL440AC

Standard Pack: 1
Weight: 9.0g (0.317oz.)

Various Options for Using Accessories

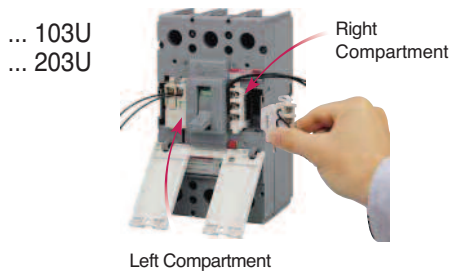

Left Compartment
Option of connecting
2xAX or AX+AL or SHT or UVT

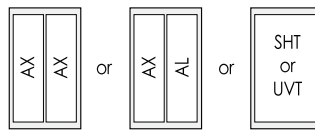

Right Compartment
Option of connecting
2xAX or AL+AX

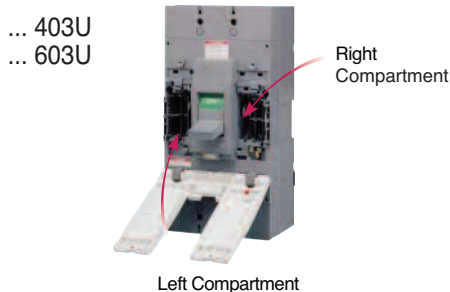
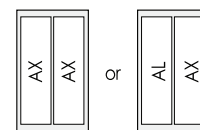

Left Compartment
Option of connecting
2xAX , 2xAL and SHT or UVT

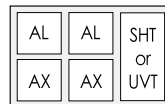

Right Compartment
Option of connecting
2xAX , 2xAL and SHT or UVT

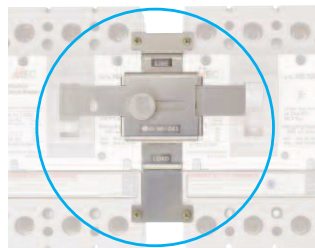
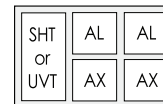

Mechanical Interlock (MI)

Cat. No.	For Use With
MI-23S	AB..103U/ AB..203U; 15 to 225A
MI-43S	AB..403U; 250 to 400A
MI-83S	AB..603U; 500 to 600A

Standard Pack: 1
Weight: 0.25kg (0.55 lb.)

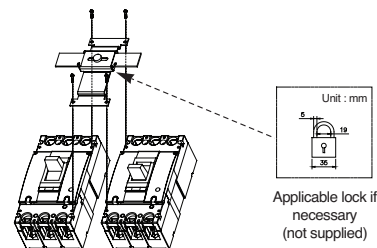

Insulation Barrier (IB)

Cat. No.	For Use With
TB-23T	AB..103U/ AB..203U; 15 to 225A
IB-400600	AB..403U/ AB..603U; 250 to 600A

Standard Pack: 1
Weight: 0.25kg (0.55 lb.)